

04-200(500)*-10G*	L = 561mm
04-200(500)*-15G*	L = 842mm
04-200(500)*-20G*	L = 1122mm
04-200(500)*-25G*	L = 1403mm
04-200(500)*-30G*	L = 1683mm
04-200(500)*-35G*	L = 1964mm
04-200(500)*-40G*	L = 2244mm
04-200(500)*-60G*	L = 3366mm
04-200(500)*-80G*	L = 4488mm

04-500x-XXGxx

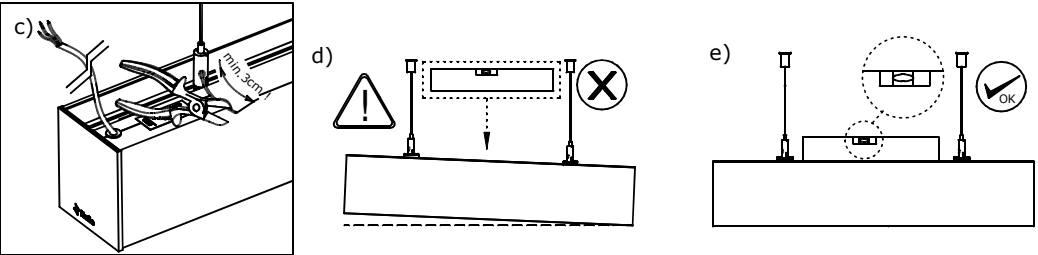

04-200(500)*-10-40G*M(M3)

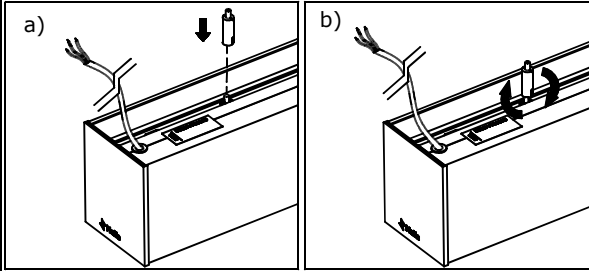
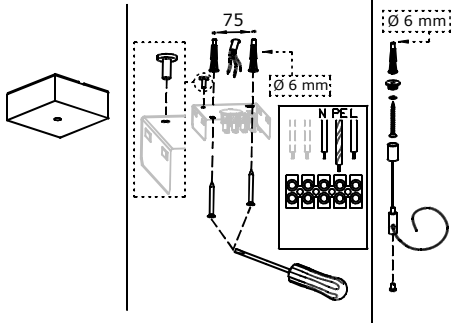
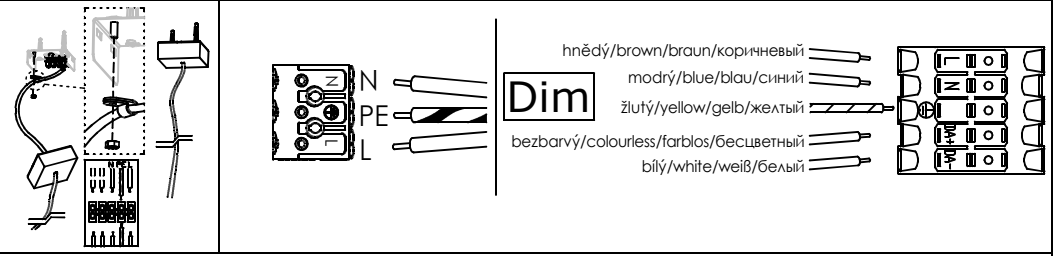
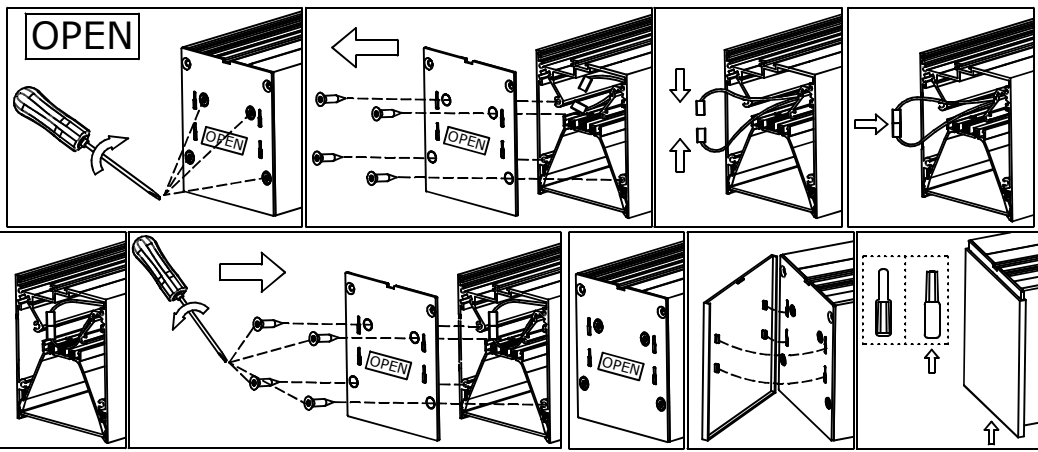

- hnědý/brown/braun/коричневый
- modrý/blue/blau/синий
- žlutý/yellow/gelb/желтый
- bezbarvý/colourless/farblös/бесцветный
- bílý/white/weiß/белый

04-200x-XXGxx

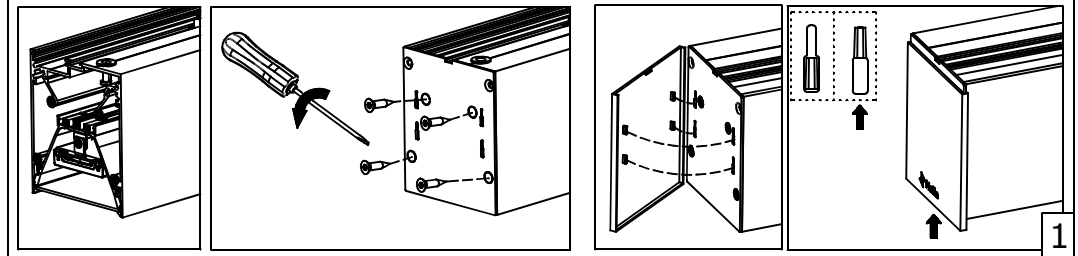
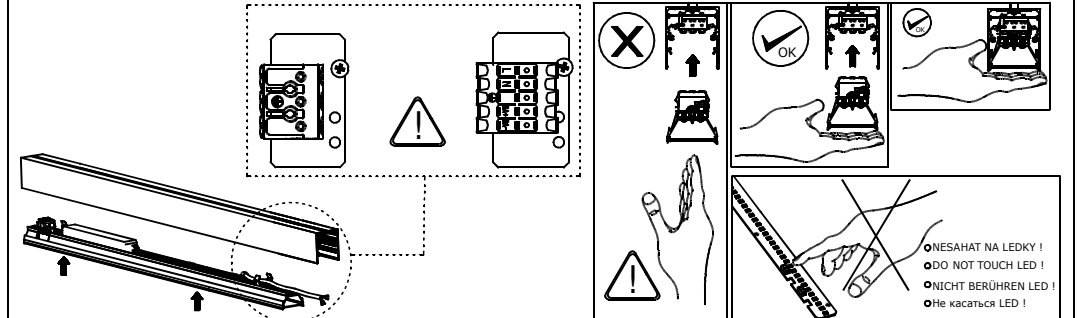
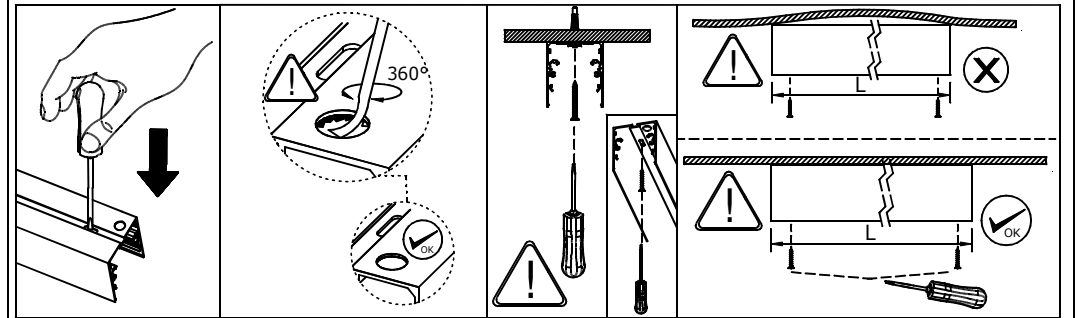
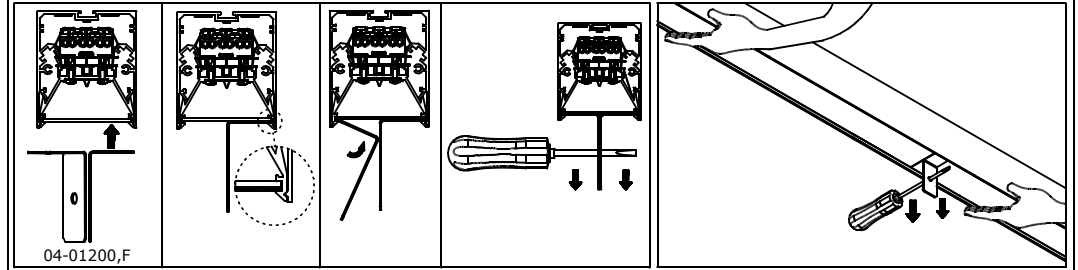

• NESAHAT NA LEDKY !
 • DO NOT TOUCH LED !
 • NICHT BERÜHREN LED !
 • Не касаться LED !

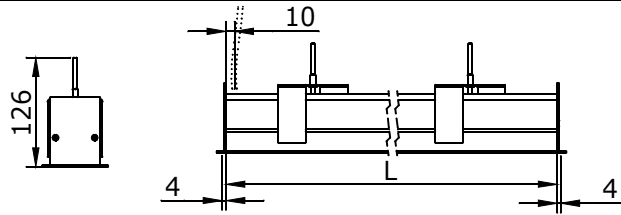
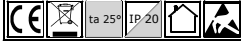

04-000*-10G*	L = 561mm
04-000*-15G*	L = 842mm
04-000*-20G*	L = 1122mm
04-000*-25G*	L = 1403mm
04-000*-30G*	L = 1683mm
04-000*-35G*	L = 1964mm
04-000*-40G*	L = 2244mm
04-000*-60G*	L = 3366mm
04-000*-80G*	L = 4488mm

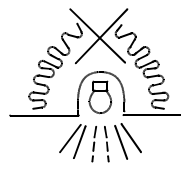
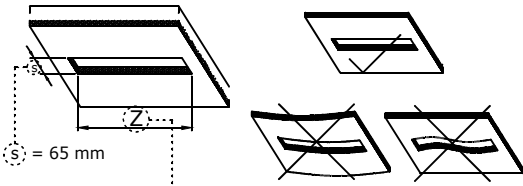

- Nepřekrývat svítidlo izolačním materiálem !
- Luminaire must not be covered with insulating material !
- Die Leuchte nicht mit Isoliermaterial überdecken !
- Не перекрывать светильник изоляционным материалом !

04-00100

04-00101

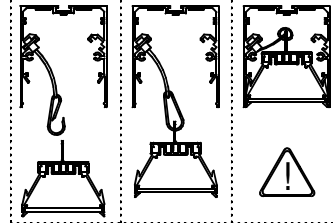
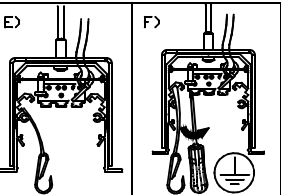
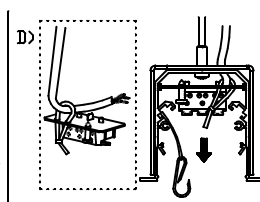
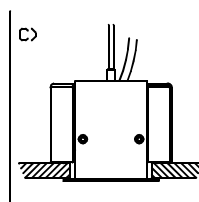
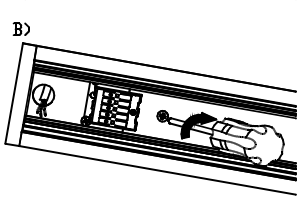
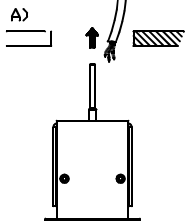
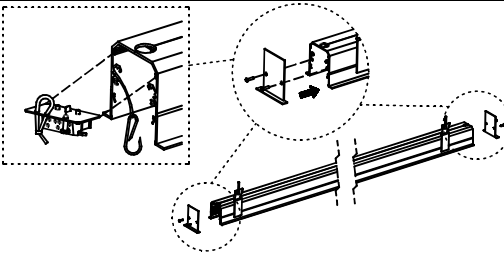
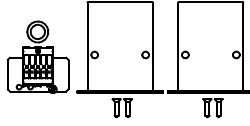
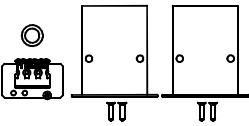

04-00100 04-00101

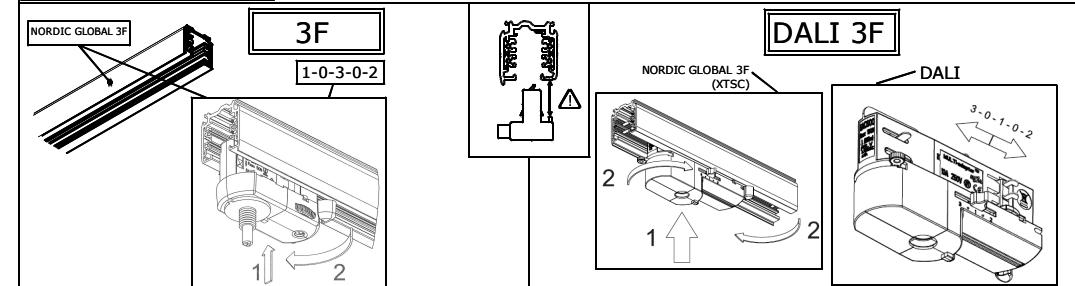
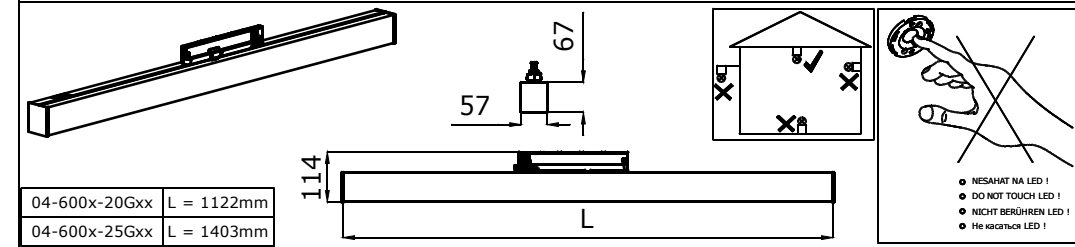
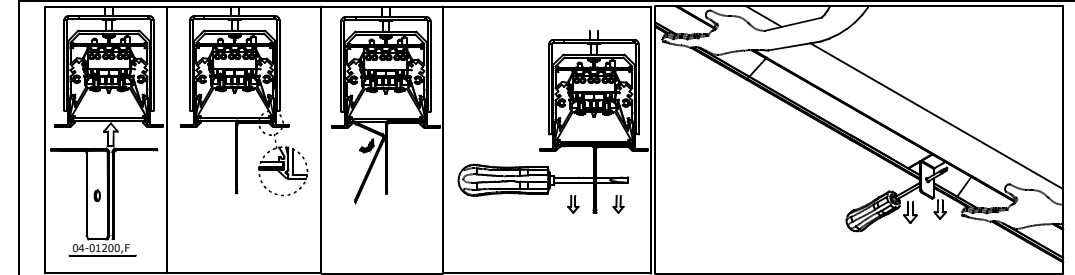
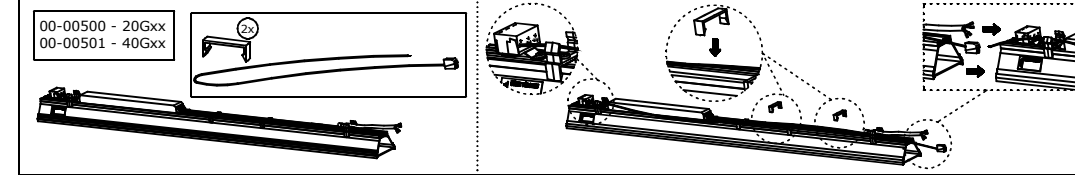
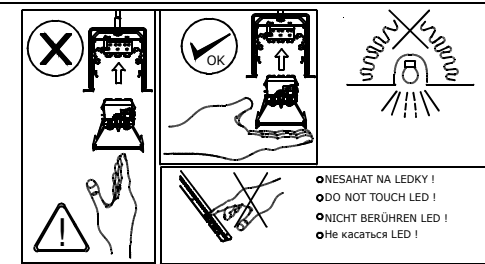
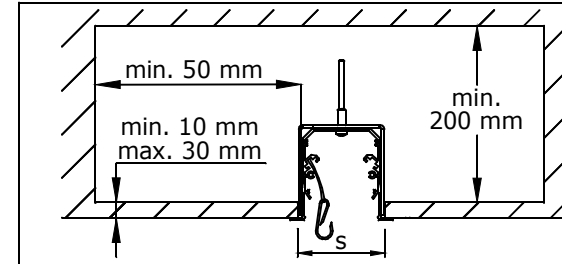
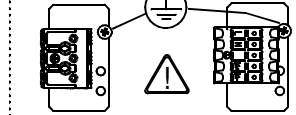

- Světelný zdroj v tomto svítidle smí vyměnit pouze výrobce nebo jeho smluvní servisní technik nebo podobně kvalifikovaná osoba!
- The light source in this luminaire may be replaced only by the manufacturer or its contractual service technician or a similarly qualified person!
- Die Lichtquelle dieser Leuchte darf nur vom Hersteller oder einem von ihm beauftragten Servicetechniker oder einer vergleichbar qualifizierten Person ersetzt werden.
- Источник света данного светильника может быть заменен только производителем, уполномоченным им сервисным техником или специалистом с соответствующей квалификацией
- Montáž smí provádět pouze pracovník s odbornou elektrotechnickou kvalifikací. Před prováděním jakékoliv údržby vypněte přívod el. proudu.
- The installation may only be carried by authorised specialist. Always switch-off the power supply before carrying out any maintenance.
- Die Leuchtenmontage kann nur von autorisiertem Fachpersonal durchgeführt werden. Vor der beliebigen Wartungsausführung die Einspeisung abschalten.
- Установка светильников разрешена только квалифицированным электромонтером.
- Výrobce nenesé odpovědnost za nesprávné zacházení s produkty.
- The manufacturer is not responsible for the incorrect use and assembly of its products.
- Der Hersteller trägt keine Verantwortung für eine falsche Verwendung des Produktes.
- Производитель не несет ответственности за неправильное обращение с продуктом.